

Varenummer: 58MI10S0075CAP
 Beskrivelse: Cylinder MI-10x75-S-CA, Ø10x75
 gummidæmpning - port M5

Mål

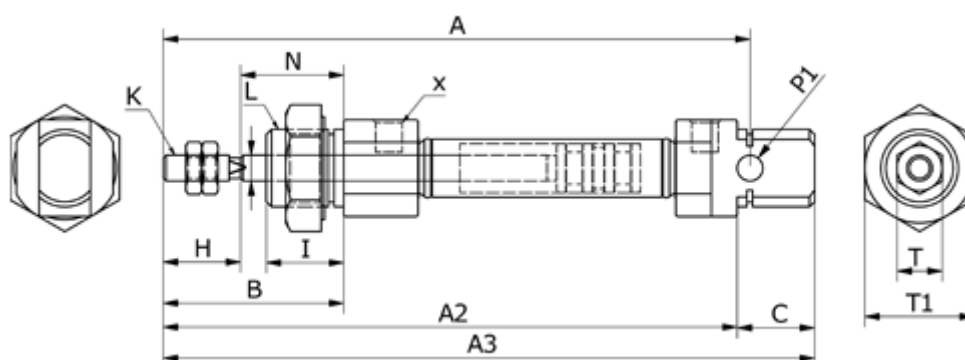

A	= 76	K	= M4x0,7	V = 4
A2	= 46	L	= M12x1,25	X = M5x0,8
A3	= 86	N	= 16	
B	= 28	O	= 10	
Boringsdiameter	= 10	P1	= 4	
C	= 12	Slaglængde	= 75	
HS	= 12	T	= 7	
I	= 12	T1	= 17	